

RM-4

TECH
REPAIR
MANUAL



Uni-Seal[®] Ultra Repair Methods

FOR RUN FLAT, PERFORMANCE, STANDARD PASSENGER,
LIGHT TRUCK & MEDIUM TRUCK TIRES

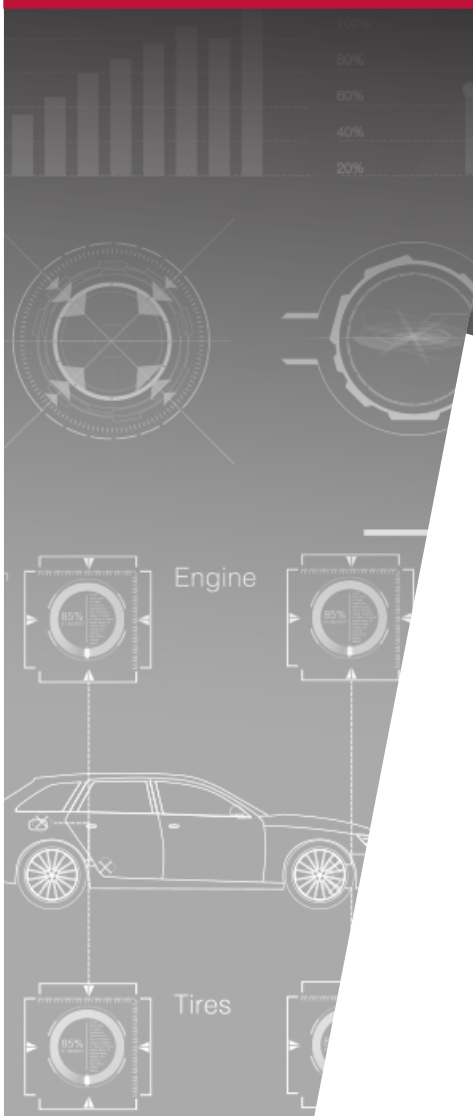

BOAB
HJULDELAR
0530-133 33 WWW.BOABHJULDELAR.SE

Uni-Seal® Ultra & Ultra Max



TECH Uni-Seal® Ultra repair units are designed to provide safe, simple, fast tire repairs that permanently repair all types of passenger tires, light truck tires, and heavy truck tires in the market today. TECH Uni-Seal® Ultras feature a lead wire for easy installation, and gray chemical cushion gum which provides maximum adhesion both in the injury and to the inner liner of the tire.

Uni-Seal® Ultra repairs meet all tire industry guidelines for proper puncture repairs and fulfill tire manufacturers' warranty requirements. These guidelines state that all injuries must be filled with a rubber stem or suitable vulcanizing material and the tire must be sealed and reinforced from the inside with a repair unit.

TECH's UL3 (249UL), UL6 (250UL), UL8 (251UL) and UL10N (290UL) Uni-Seal® Ultras repair 3mm (1/8"), 6mm (1/4"), 8mm (5/16") and 10mm (3/8") injuries. TECH's UL3, UL6, and UL8 repairs have all passed the FMVSS 139 test mandated under the TREAD act. This is the most stringent passenger tire endurance test ever established by NHTSA.

TECH also produces Uni-Seal® Ultra Max. These repairs feature a lead wire and gray chemical cushion gum as mentioned above and provide maximum reinforcement in radial and bias truck tire injuries. Uni-Seal® Ultra Max accommodates both tire constructions with unique cross weave fabric plies in the cap of the repair. The UL10 (291UL) repairs 10mm (3/8") injuries and the UL13 (292UL) repairs 13mm (1/2") injuries.

This repair manual has been created to instruct each customer in the proper installation procedures of TECH Uni-Seal® Ultra and Uni-Seal® Ultra Max, ensuring a safe, permanently repaired tire is returned to service every time.

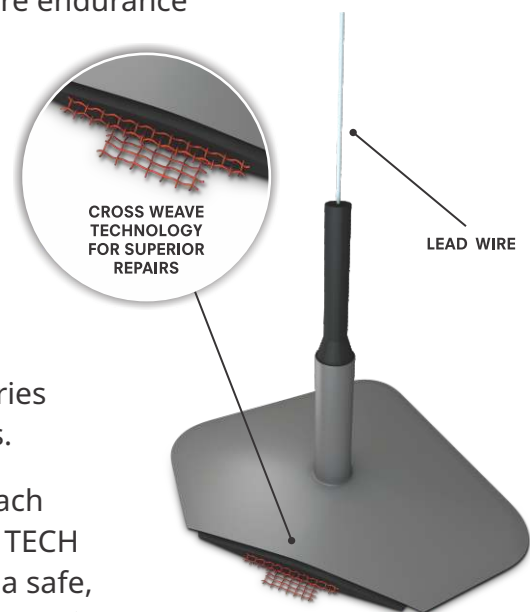

Uni-Seal® Ultra Repair Kit



Performance Tire Nail Hole Repair Kit FEATURING UNI-SEAL® ULTRA

- **One kit does it all!** 898 Performance Tire repair kit has all the necessary tools to repair run-flat tires, speed rated tires, and standard passenger tires
- Uni-Seal® Ultra Repairs prevent moisture and debris from entering the injury, which protects the steel belts from corrosion
- Permanently seals inner liner
- Meets or exceeds tire manufacturers' warranties, and also meets industry recommended practices
- Uni-Seal® Ultra Repairs passed the FMVSS 139 tire test created under the TREAD Act
- TECH's Performance Tire Repair Kit includes the RM-4 Uni-Seal® Ultra How-To-Repair Manual

ITEM NO. 898 KIT CONTAINS:

249UL Uni-Seal Ultras	RH140 Contour Wheel
250UL Uni-Seal Ultras	910 Cement Tool
269 Carbide Cutter	911 Allen Wrench
270P Carbide Cutter	913 Slip Joint Pliers
TRT105 Measuring Tool	915 Spiral Cement Tool
704A Rub-O-Matic	933 Rubber Scraper
738 Security Coat	936 Stitcher
760 Vulcanizing Fluid	951 Paint Sticks (12)
S1032AC Low RPM Buffer	S923 Safety Glasses
S1040 Adaptor	TK Knife
S1043 Adaptor	RM-4 Repair Manual
S1046 (2) Adaptors	111TM Repair Template
S893 Texture Brush	

TECH Repair Limitations

Repair of Run Flat Tires

Run Flat tires must be removed from the wheel and inspected. These tires have been engineered to support the load of the vehicle with little to no air pressure for a specified amount of time by the tire manufacturer. Distance traveled, driving speed and vehicle maneuvering at low pressure may affect the tire's integrity and reparability. These tires are susceptible to inner liner separations when run flat for extended periods of time.

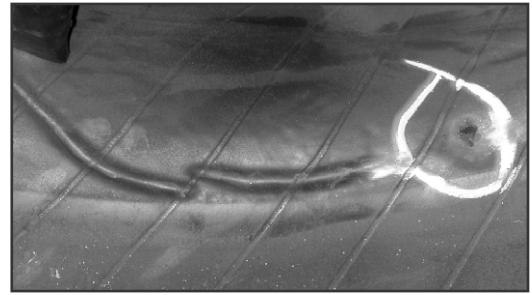

This photo shows innerliner separation in a run flat tire. The tire should not be repaired if this condition is present.

Once the tire has been removed from the wheel, thoroughly inspected, and determined to be repairable, it may be repaired using TECH Uni-Seal® Ultra or Two-Piece Repair System. Punctures must be limited to the crown area as shown in Figure A. The maximum size injury is 6mm (1/4"). One injury per tire may be repaired.

Consult the tire manufacturer's warranty for specific information regarding repair of Run Flat tires. TECH's recommendations for repair of Run Flat tires are not to supersede any recommendations of new tire manufacturers. TECH's recommendations are based on tests conducted at TECH's test facility and at an independent lab. TECH is continuously testing new Run Flat technologies as they enter the market.

Repair of Performance Tires

Performance tires H, V, W, Y, and Z rated can be repaired using TECH's UL3 or UL6 Uni-Seal® Ultras in the crown T-T area as shown in Figure A. One injury per tire up to 6mm (1/4") in diameter may be repaired. Test results in our test facility and at an independent lab have shown the tire's speed rating is maintained. Additional repairs can be made, however the tire's speed rating is reduced below an "H". TECH's recommendations for repair of performance tires are not to supersede any recommendations of new tire manufacturers.

Repair of Standard Passenger Tires

Passenger tires T rated and below can be repaired using TECH's UL3 or UL6 Uni-Seal® Ultras in the crown area shown in Figure A. TECH places no limitations on the number of punctures repaired in a tire as long as no two injuries are in the same radial cord and the repair units do not overlap. TECH's recommendations are based on tests conducted at TECH's test facility and at an independent lab. TECH's recommendations for repair of standard passenger tires are not to supersede any recommendations of new tire manufacturers.

Repair of Steel Cord Light, Medium & Heavy Truck Tires

Truck tires can be repaired using TECH's UL6, UL8 and UL10N Uni-Seal® Ultras or UL10 and UL13 Uni-Seal® Ultra Max repair units in the crown area as shown in Figure A. TECH's recommendations are based on tests conducted at TECH's test facility and at an independent lab. TECH's recommendations for repair of light, medium, and heavy truck tires are not to supersede any recommendations of new tire manufacturers.

One Piece Repair Limitations



WARNING

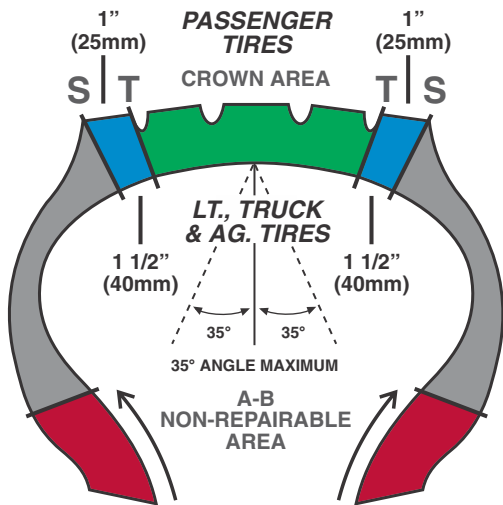

Failure to properly repair tire could cause **SUDDEN TIRE FAILURE, RESULTING IN SERIOUS INJURY OR DEATH.** Carefully read and follow these instructions.

Tire Repair Limitations (Figure A.)



Uni-Seal Ultra repairs are designed for use in the Crown (T-T) area of the tire only.

UNI-SEAL® ULTRA REPAIR CHART

Type of Tire	Repair Unit	Carbide Cutter	Prepared Crown Injury Size Ø	Number of Repairs Per Tire	
RUN FLAT TIRE	UL3 (249UL)	CC3 (269)	3mm (1/8")	1	<i>Repairs must not overlap or be on the same radial ply.</i>
	UL6 (250UL)	CC6 (270)	6mm (1/4")	1	
PERFORMANCE TIRE RATED H, V, W, Y or Z	UL3 (249UL)	CC3 (269)	3mm (1/8")	1	
	UL6 (250UL)	CC6 (270)	6mm (1/4")	1	
STANDARD PASSENGER & FABRIC CORD LIGHT TRUCK TIRES	UL3 (249UL)	CC3 (269)	3mm (1/8")	NO LIMIT	
	UL6 (250UL)	CC6 (270)	6mm (1/4")	NO LIMIT	
STEEL CORD LIGHT, MEDIUM & HEAVY TRUCK TIRE	UL6 (250UL)	CC6 (270)	6mm (1/4")	NO LIMIT	
	UL8 (251UL)	CC8 (271)	8mm (5/16")	NO LIMIT	
	UL10 (291UL)	CC10 (271/38)	10mm (3/8")	4	
	UL10N (290UL)	CC10 (271/38)	10mm (3/8")	4	
	UL13 (292UL)	CC13 (272)	13mm (1/2")	4	

NOTE: THIS CHART SERVES ONLY AS A SUGGESTED GUIDELINE. INDUSTRY RECOMMENDED PRACTICES AND TIRE MANUFACTURER'S RECOMMENDATIONS SHOULD ALSO BE FOLLOWED.

Please Read Before Performing Any Tire Repair:

- Protective eyewear must be worn while repairing tires.
- Tire industry standards state that all injuries must be filled with a rubber stem or suitable vulcanizing material and a repair unit applied to the inner liner.
- Failure to follow industry recommendations may result in premature tire failure.
- Tire manufacturers' warranties and policies regarding repair of radial passenger, performance, or run flat tires may differ. These policies supersede those of TECH.
- Although a tire may be rated for high speed, TECH does not endorse the operation of a motor vehicle in an unsafe or unlawful manner.
- Chemicals used during the repair process are extremely flammable. Do not use near sources of ignition.
- Failure to follow the procedures shown in this manual may result in premature tire failure. This could result in serious injury or death.
- Failure to follow procedures in this manual will void TECH's warranty relating to Uni-Seal® Ultra repairs. TECH will not be responsible for any damages or losses, direct or indirect, related to or associated with the failure to follow the instructions contained in this manual.

Tire Inspection & Pre-Cleaning

The tire inspection process is critical in determining if the tire can safely be repaired and returned to service. The inspection should be done with the tire removed from the wheel and placed on a tire spreader using adequate lighting. The technician must be able to examine the tire beads, interior and exterior sidewalls, and the tread area.

Non-Repairable Conditions



1. Injury no greater than 1/4" for passenger tires. Injury no greater than 3/8" for light truck/truck tires.



2. Run flat or under-inflated

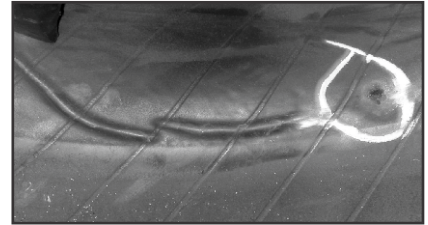

3. Inner liner separation



4. Casing separation



5. Excessive tread wear



6. Exposed plies/cables



7. Deformed bead, exposed fabric or steel

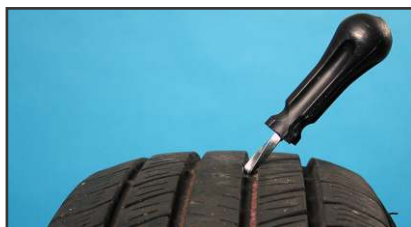

8. If injury angle exceeds 35 degrees, a 2-piece repair must be used.



9. Ozone cracking



10. Tire damage from impacts

Tire Inspection & Pre-Cleaning



1. Locate and mark all damage on the inside and outside of the tire while checking for separation.



2. Determine the size and angle of the injury using the TRT105 injury measuring tool. If the angle exceeds 35 degrees, a two-piece repair must be used.



3. Pre-clean the inner liner with Rub-O-Matic Rubber Cleaner #704 or #704A and a scraper 2 to 3 times to remove contaminants.

Use UL3 (249UL) with
CC3 (269) Cutter

Use UL6 (250UL) with
CC6 (270) Cutter

Use UL8 (251UL) with
CC8 (271) Cutter

Use UL10 (291UL) with
CC10 (271/38) Cutter

Use UL13 (292UL) with
CC13 (272) Cutter



TECH TIP:

Insert the **TRT105** measuring tool into the injury from the inside of the tire. Apply firm pressure to the handle while rotating the tool in a circular motion. When the tool meets resistance, find the closest visible line to the inner liner. Refer to the illustration (right) to determine the injury size.

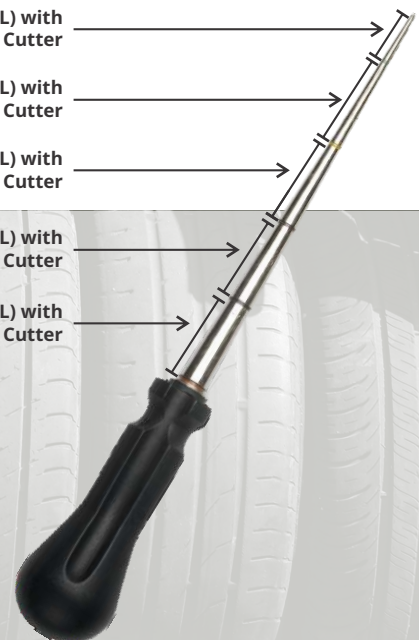

Injury Preparation

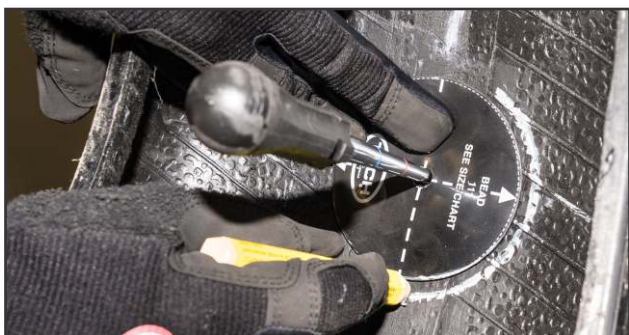

4. Outline the area to be buffed 1/2" larger than the repair or use the appropriate repair template.



5. Using a low speed buffer (maximum 5,000 rpm) and an appropriate inner liner buffing wheel, buff the entire outlined area to a #1 or #2 buffed texture.

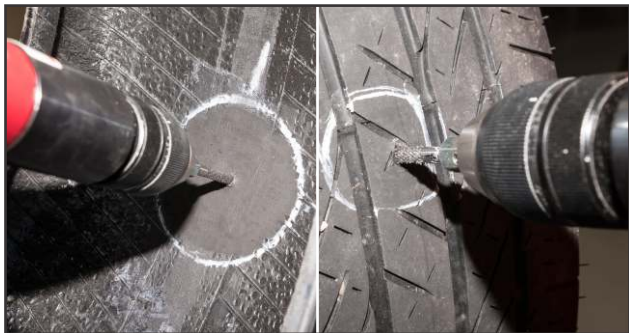

6. Damaged rubber and steel should be removed from the injury using a carbide cutter on a low speed air/electric drill, maximum 1,200 rpm. Drill the injury from the inside of the tire 3 to 5 times, followed by 3 to 5 times from the outside. In passenger tires, drilling the injury can be done with a 2,500 rpm air buffer as long as care is taken not to scorch the injury channel.



7. The injury should be inspected after drilling is complete by flexing the tire and probing the injury with a pointed awl to make sure all splits and loose material have been removed.



TECH TIPS:

- Tire industry puncture repair guidelines state that the inner liner should be buffed to a #1 or #2 buffed texture using a low speed air tool, maximum 5,000 rpm.
- An even velvet texture minimizes the chance of trapped air while maximizing adhesion.



Cleaning & Cement Application

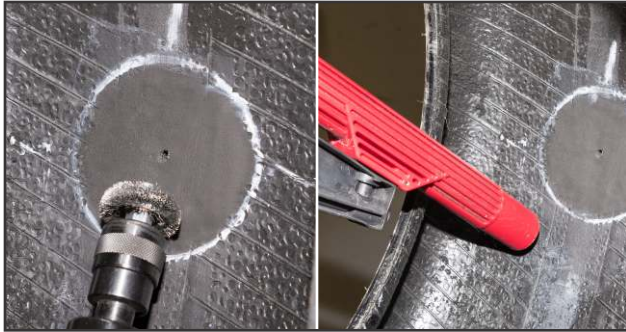

8. Use a soft wire brush on a low rpm buffer to remove buffing debris. Do not apply excess pressure as this could alter the buffed texture and reduce repair adhesion. Remove all debris from the tire using a vacuum, being careful not to contact and contaminate the buffed surface.



9. Using a fluted cement tool for injuries 6mm (1/4") or smaller or a spiral cement tool for larger punctures, apply Chemical Vulcanizing Fluid #760 or Heavy Duty Blue Vulcanizing Fluid #775 to the injury 3 to 5 times.



10. Apply a thin, even coat of Chemical Vulcanizing Fluid #760 or Heavy Duty Blue Vulcanizing Fluid #775 to the buffed surface.



11. Allow 3-5 minutes drying time for #760 or 5-8 minutes for #775. Additional drying time may be necessary in adverse weather conditions. Vulcanizing Fluid must be completely dry.



TECH TIPS:

- Do not use a compressed air line to clean the buffed area, as contamination from moisture and oil will occur.
- When cleaning the tire, care should be taken to not let anything touch the buffed surface.
- Rub-O-Matic rubber cleaner can be used to remove buffing dust and debris if it is applied using a clean, lint-free cloth. 3 to 5 minutes of drying time should be allowed before applying chemical vulcanizing fluid.
- Do not use any outside heat sources or open flame to shorten the drying time of vulcanizing fluid. This will adversely affect the vulcanizing fluid and potentially lead to premature repair failure.

Repair Installation & Finishing



12. Remove the blue poly from the stem by pulling and twisting the repair as shown.

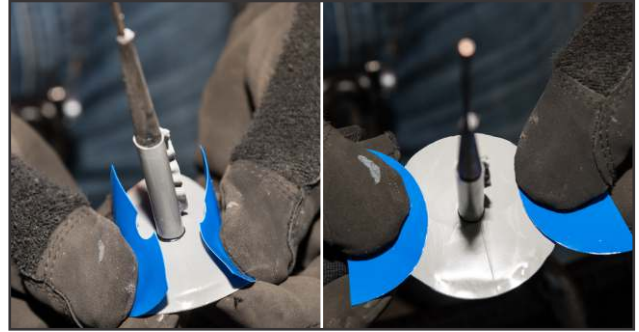

13. Reposition the poly on the cap to prevent contamination of the gray gum and allow easier removal of trapped air during installation.

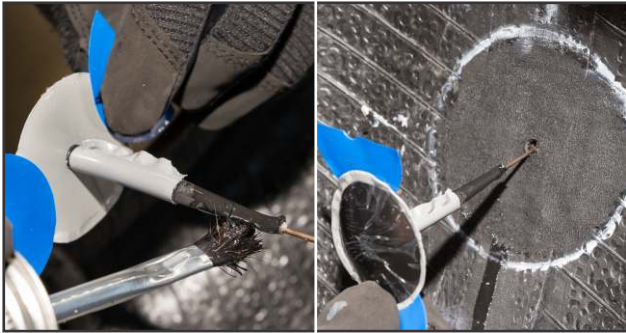

14. Apply a small amount of vulcanizing fluid to the black tapered portion of the stem. Relax the beads of the tire. Insert the lead wire through the injury.



15. Grasp the wire with pliers and pull the stem through the tire until the cap forms a slight indentation.



16. Press down the repair with your thumb from the center out.



17. With the blue poly still positioned under the cap, stitch the repair unit from the center out using firm pressure.



TECH TIP:

Tech Uni-Seal Stems are slightly larger than the prepared injury, resulting in a compression fit with excellent adhesion. Placing a small amount of vulcanizing fluid on the stem just before inserting it into the tire injury provides lubrication for easier installation.

Repair Installation & Finishing



18. Remove the poly from the cap, press down the sides and continue stitching toward the edges of the repair. Stitch with firm pressure in the opposite direction to ensure air is removed.



19. Remove the clear protective poly from the top of the repair.



20. Seal the edge of the repair and the over buffed area of the inner liner with Tech Security Coat #738 or Butyl Liner Repair Sealer #739.



21. With the stem relaxed, cut off the excess 1/8" (3mm) above the tread surface.

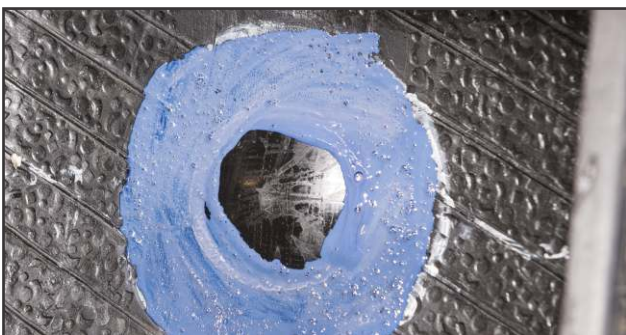

22. The tire is ready to return to service.



**TECH
TIP:**

TECH Security Coat #738 and Butyl Liner Repair Sealer #739 are designed to replace the inner liner that was removed during the buffing process and promote better air retention.



World-Renowned Tire & Wheel Service Solutions

TECH distributes our products to more than 95 countries.



P.O. Box 486, Johnstown, Ohio 43031-0486, USA
PHONE: 740-967-9015 FAX: 740-967-1039 1-800-433-TECH or 1-800-336-TECH
www.techtirerepairs.com