

DWA 1100

8-CCD WHEEL
ALIGNMENT
FOR CAR AND
LIGHT TRUCK



CEMB

DWA 1100

LITHIUM BATTERIES: 24 hours of work, 1 year guaranteed
FEATHERWEIGHT SENSORS: only 2.6 kg
Immediate connection with innovative **BT² wireless communication**
SILICON ACCELEROMETER: shock-proof
DIRECT RECHARGE OF SENSORS: no need to disassemble them
Designed to fit also SUV tyres: **NO EXTENSIONS REQUIRED**
Truck and bus wheel alignment **AVAILABLE WITH SMALL EXTRA CHARGE**
SUNLIGHT FILTER: over 12 m wheelbase even in outdoor sun exposed environment
Simple and **user-friendly software**

BATTERIE AL LITIO: 24 ore di lavoro, garanzia 1 anno
RILEVATORI PESO PIUMA: solo 2.6 kg
Connessione immediata con l'innovativa **comunicazione senza fili BT²**
ACCELEROMETRO IN SILICIO: insensibile agli urti
RICARICA DIRETTA DEI RILEVATORI: nessuna necessità di smontarli
Adatto anche per pneumatici SUV: **NON RICHIEDE ESTENSIONI**
Allineamento autocarro e bus **POSSIBILE CON PICCOLO SOVRAPPREZZO**
FILTRO SOLARE: passo oltre 12 m anche in ambienti aperti e soleggiati
Software semplice e **intuitivo**

BATTERIES AU LITHIUM: 24 heures de travail, garantie 1 an
DÉTECTEURS ULTRA LÉGERS: 2.6 kg seulement
Connexion avancée **immédiate** sans fils **BT²**
ACCÉLÉROMÈTRE EN SILICIUM: insensible aux chocs
RECHARGE DIRECTE DES DÉTECTEURS: pas besoin de les désassembler
Adapté également aux pneumatiques de SUV: **NE NÉCESSITE PAS D'EXTENSIONS**
Alignement camions et autobus **POSSIBLE AVEC UNE PETITE MAJORATION DE PRIX**
FILTRE DE SOLEIL: empattement de plus de 12 m y compris à ciel ouvert et en présence de soleil
Logiciel simple et **intuitif**

BESONDERS LANGE LEBENSDAUER: 24 Arbeitsstunden, 1 Jahr Garantie
FEDERLEICHTE MESSKÖPFE: nur 2.6 kg Gewicht
Übertragung der Messdaten ohne Kabel mit **BT2 sofortige Verbindung**
BESCHLEUNIGUNGSMESSER AUS SILICIUM: schlagfest
DIREKTE AUFLADUNG VON SENSOREN: kein Zeitverlust durch Demontage
Für die neuen SUV-reifen dimensioniert: **KEINE VERLÄNGERUNGEN MEHR NÖTIG**
Achsmessung von LKWs und Bussen **MIT KLEINEM PREISAUFSCHLAG MÖGLICH**
SONNENLICHTFILTER: keine verlängerungen mehr nötig Achsabstand über 12 m, auch im Freien und bei Sonneneinwirkung
Einfache und **intuitive Software**

BATERÍAS DE LITIO: 24 horas de trabajo, garantía 1 año
CAPTADORES PESOS PLUMA: sólo 2.6 kg
Conexión inmediata con la innovadora **comunicación inalámbrica BT²**
ACELERÓMETRO EN SILICIO: insensible a los golpes
RECARGA DIRECTA DE LOS CAPTADORES: ninguna necesidad de desmontarlos
Adecuado también para neumáticos SUV: **NO NECESITA EXTENSIONES**
Alineación camión y bus **POSIBLE CON UN PEQUEÑO SOBREPREGIO**
FILTRO SOLAR: paso superior a 12 m también en ambientes abiertos y soleados
Software sencillo y **fácil de usar**

SOFTWARE



FAST caster swing
Sterzata FAST
Braquage FAST
Lenkeinschlag FAST
Viraje FAST



Adjust two axles in one screen
Regolazione di entrambi gli assi in un'unica schermata
Réglage des deux essieux sur une unique page
Einstellung beider Achse in einem einzigen Bildschirm
Ajuste de ambos los ejes en una única pantalla



Direct spoiler, no extensions required
Funzione spoiler automatico, non richiede l'utilizzo di estensioni
Fonction becquet automatique (ne nécessite pas l'utilisation d'extensions)
Automatisches Spoilerprogramm Verwendung von Verlängerungen nicht nötig
Función spoiler automático, no requiere utilizo de extensiones



Clear help for adjustment
Visualizzazione in dettaglio delle regolazioni
Visualisation détaillée des réglages
Detaillierte Ansicht der Einstellungen
Indicación detallada puntos de arreglo



AUDIT function for the identification of driving problems
Funzione AUDIT per la diagnosi completa dei disturbi di guida
Fonction AUDIT pour l'identification des problèmes de conduite
Funktion AUDIT für die Diagnose der Fahrstörungen
Función AUDIT para la identificación de problemas de conducción

VERSIONS

DWA1100 (with cabinet)

 **Ergonomic design**
Industrial computer
No moving parts more likely to break
Data update through USB

 Design ergonomico
 Computer industriale
 Senza parti in movimento più soggette a rotture
 Aggiornamento dati via USB

 Forme ergonomique
 Ordinateur industriel
 Sans disque en mouvement qui risquent davantage les ruptures
 Mise à jour des données via USB

 Ergonomisches Design
 Industrieller Computer
 Ohne bewegliche Scheiben, dem stärkeren Bruch ausgesetzt sind
 Daten-Update via USB

 Diseño ergonómico
 Ordenador industrial
 Sin partes en movimiento con más probabilidad de romperse
 Actualización datos por medio de USB

DWA1100 Light

 **No CABINET!** Save your working space with your laptop!

 **Senza ARMADIO!** Risparmi spazio di lavoro ed usi il tuo pc!

 **Sans ARMOIRE!** Gains d'espace de travail et utilisation de son propre PC!



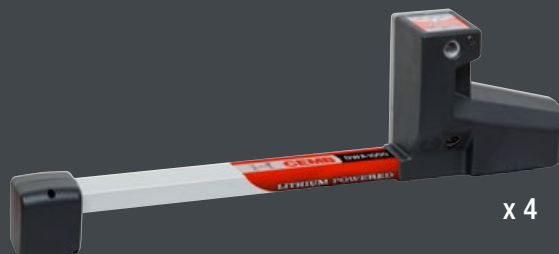

 **Ohne STEUERSCHRANK!** Sie sparen Raum und benutzen Ihren eigenen PC!



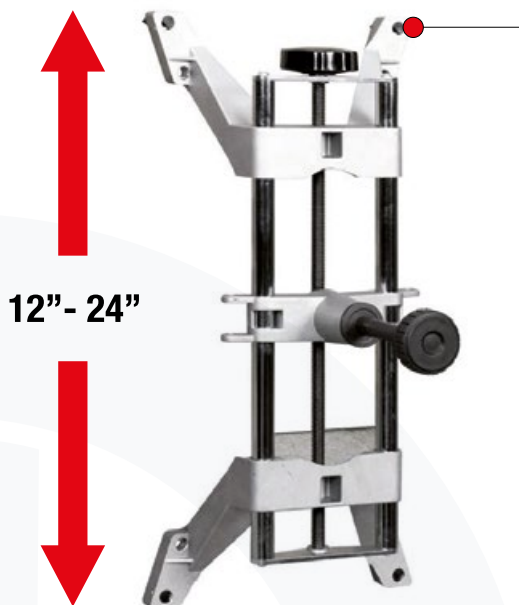

 **¡Sin ARMARIO!** ¡Ahorras espacio de trabajo y utilizas tu PC!







STANDARD CONFIGURATION







 **Optional up to 30"**
 Opzionale fino a 30"
 Option jusqu'à 30"
 Opzional bis zu 30"
 Opcional hasta 30"

 **Metal 80 mm grips for 4-WD, SUV, light trucks and rims with hubcap**
 Unghiette metalliche 80mm per 4-WD, SUV, veicoli commerciali leggeri e cerchi con coprimozzo
 Onglets universels de 80 mm en métal, pour 4WD, SUV et véhicules de transport léger
 Universal-Radklammerfingern aus Metall, 80 mm, für 4WD, SUV und Kleintransporter
 Uñas universales 80 mm en metal, para todo terreno, SUV y vehiculos de transporte ligero

 **Metal 48 mm grips with reference surface to optimize runout**
 Unghiette metalliche 48 mm con piano di riferimento per l'ottimizzazione del runout
 Onglets de 48 mm en métal avec surface de référence pour optimiser le run-out
 Radklammerfingern aus Metall 48mm mit Auflageoberfläche zur Reduzierung des Runout-Fehlers
 Uñas 48 mm en metal con superficie de referimiento para optimizar el run out





OPTIONAL ACCESSORIES







 **Clamp supporting arms and set of tips for tyres with external diameter up to 31" (with optional support arms up to 40")**
 Bracci e gruppo di puntali per aggrappo in appoggio a pneumatici con diametro esterno fino a 31" (con bracci di supporto opzionali fino a 40")
 Bras et groupe de broches d'accrochage en appui sur pneumatiques de diamètre externe jusqu'a 31" (avec bras de support optionnel jusqu'a 40")
 Klemmarme und Positionsfinger für Radklammern zum Auflegen auf Reifen mit Aussendurchmesser bis zu 31" (mit optionalen Stützarmen bis zu 40")
 Brazos y grupo de puntales para mordaza en apoyo a neumáticos con diámetro externo hasta 31" (opcional hasta 40")

Grips for all rims and tyres are available



 **Metal grips for clamping on steel rims from the inside**
 Unghiette in metallo per aggrappo dall'interno su cerchi in ferro
 Onglets en métal pour accrochage de l'intérieur sur jantes en fer
 Metallkrallen zum Halten von innen bei Eisenfelgen
 Uñas en metal para mordaza desde el interior en llantas en hierro

STANDARD COMPOSITION

-  Computer with WINDOWS operating system, 27" TFT monitor, colour printer, USB keyboard, mouse (only for DWA1100)
4 car sensors
4 clamps + safety elastic band + 2 set of grips
2 mechanical turntables for cars
Steering lock + Brake pedal lock
Wheel alignment software and database for CARS
-  Computer con sistema operativo WINDOWS, Monitor 27" TFT, stampante a colori, tastiera USB, mouse (solo per DWA1100)
4 rilevatori vettura
4 aggrappi + elastico di sicurezza + 2 set di unghiette
2 piatti rotanti meccanici per vettura
Bloccasterzo + premipedale
Software e database autoveicoli
-  Ordinateur avec système d'exploitation WINDOWS, moniteur 27", imprimante couleur, clavier USB, souris (seulement pour DWA1100)
4 détecteurs voiture
4 griffes + élastique de sécurité + 2 jeux d'onglets
2 plateaux rotatifs pour voitures
Blocage direction + presseur pédale
Logiciel et base de données pour autos
-  Computer mit Betriebssystem WINDOWS, 27"-TFT-Monitor, Farbdrucker, Tastatur USB, Mouse (nur für DWA1100)
4 Messköpfe für PKW
4 Radklammern + elastisches Schutzband + 2 Radklammerfinger
2 vordere Drehteller für PKW
1 Lenkradfeststeller, 1 Bremspedalfeststeller
Software und Database für Fahrzeugen
-  Ordenador con sistema operativo WINDOWS, monitor 27" TFT, impresora de color, teclado USB, ratón (solo para DWA1100)
4 captadores coche
4 mordazas + elástico de seguridad + 2 equipos de uñas
2 platos rotatorios para coches
Dispositivo antirrobo + apretapedal
Software y base de datos para coches

TECHNICAL DATA

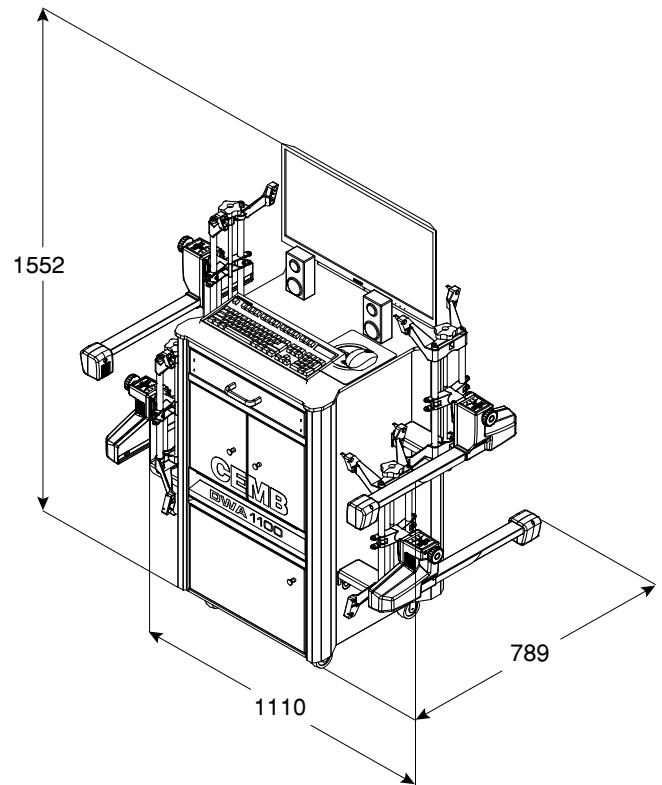

PACKAGE DIMENSIONS AND GROSS WEIGHT:





113x113x113 cm (44,5x44,5x44,5")

220 Kg





Net weight: 155 Kg

OPTIONS







-  **Premium turntables:** capacity 1000 kg per plate, Ø 35 cm, with rubber supports
-  **Piatti Premium:** portata 1000 kg per piatto, Ø 35 cm, con supporti in gomma
-  **Plateaux Premium:** portée 1000 kg par plateau, Ø 35 cm, avec supports en caoutchouc
-  **Premium-Teller:** Tragkraft 1000 kg pro Teller, Ø 35 cm, mit Auflagen aus Gummi
-  **Platos Premium:** capacidad de 1000 kg por plato, Ø 35 cm, con soportes de goma



-  **WiFi connection for automatic software updates**
-  Collegamento wifi per l'aggiornamento automatico del software
-  Connexion Wi-Fi pour la mise à jour du logiciel
-  Wifi-Verbindung zur automatischen Aktualisierung der Software
-  Conexión wifi para actualizar automáticamente el software



-  **Truck and Bus upgrade kit**
-  Kit di conversione auto/camion-bus
-  Kit de conversion auto/camion-bus
-  Pkw - Lkw Nachrüstatz
-  Equipo de conversión coche/camióbus



BALANCING MACHINES

CEMB S.p.A.

Via Risorgimento, 9
23826 Mandello del Lario (LC) - Italy
www.cemb.com



Garage equipment division
CEMB - ITALY
Plant and Training Center
Phone +39 0341 706111
garage@cemb.com

CEMB USA - BL Systems Inc.
2873 Ramsey Road
Gainesville, GA 30501 - USA
Phone +001 678 717 1050
Fax +001 678 717 1056
sales@cemb-usa.com



All the data and features mentioned in this catalogue are purely for information and do not constitute any commitment on the part of our company, which reserves the right to make any and all alterations it may consider suitable without notice.