

DWA 1100TRUCK

8-CCD SENSOR
TRUCK ALIGNMENT
SYSTEM



CEMB

DWA 1100 TRUCK

UK LITHIUM BATTERIES: 24 hours of work, 1 year guaranteed
FEATHERWEIGHT SENSORS: only 2.8 kg
 Immediate connection with innovative **BT² wireless communication**
SILICON ACCELEROMETER: shock-proof
SUNLIGHT FILTER: over 12 m wheelbase even in outdoor sun exposed environment
 Simple and **user-friendly software**

IT BATTERIE AL LITIO: 24 ore di lavoro, garanzia 1 anno
RILEVATORI PESO PIUMA: solo 2.8 kg
 Connessione immediata con l'innovativa **comunicazione senza fili BT²**
ACCELEROMETRO IN SILICIO: insensibile agli urti
FILTRO SOLARE: passo oltre 12 m anche in ambienti aperti e soleggiati
Software semplice e intuitivo

FR BATTERIES AU LITHIUM: 24 heures de travail, garantie 1 an
DÉTECTEURS ULTRA LÉGERS: 2.8 kg seulement
Connexion avancée immédiate sans fils BT²
ACCÉLÉROMÈTRE EN SILICIUM: insensible aux chocs
FILTRE DE SOLEIL: empattement de plus de 12 m y compris à ciel ouvert et en présence de soleil
Logiciel simple et intuitif

DE BESONDERS LANGE LEBENSDAUER: 24 Arbeitsstunden, 1 Jahr Garantie
FEDERLEICHTE MESSKÖPFE: nur 2.8 kg Gewicht
 Übertragung der Messdaten ohne Kabel mit **BT² sofortige Verbindung**
BESCHLEUNIGUNGSMESSER AUS SILICIUM: schlagfest
SONNENLICHTFILTER: keine verlängerungen mehr nötig Achsabstand über 12 m, auch im Freien und bei Sonneneinwirkung
 Einfache und **intuitive Software**

ES BATERÍAS DE LITIO: 24 horas de trabajo, garantía 1 año
CAPTADORES PESOS PLUMA: sólo 2.8 kg
 Conexión inmediata con la innovadora **comunicación inalámbrica BT²**
ACELERÓMETRO EN SILICIO: insensible a los golpes
FILTRO SOLAR: paso superior a 12 m también en ambientes abiertos y asoleados
Software sencillo y fácil de usar



SOFTWARE

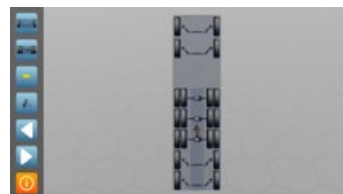

UK Adjust two axles in one screen
IT Regolazione di entrambi gli assi in un'unica schermata
FR Réglage des deux essieux sur une unique page
DE Einstellung beider Achse in einem einzigen Bildschirm
ES Ajuste de ambos los ejes en una única pantalla



UK Step by step procedure up to 7 axles
IT Procedura guidata fino a 7 assi
FR Procédure pas à pas jusqu'à 7 essieux
DE Schritt für Schritt-Verfahren bis zu 7 Achsen
ES Procedimiento pilotado hasta 7 ejes

UK 2 measuring heads mode Quick measurement of front axle
IT Modalità a due sensori Misurazione rapida dell'asse anteriore
FR Mode deux capteurs Mesure rapide de l'essieu avant
DE Zwei-Sensoren Modus Schnelle Messung der Vorderachse
ES Modalidad 2 sensores Medición rápida del eje anterior





UK AUDIT function for the identification of driving problems
IT Funzione AUDIT per la diagnosi completa dei disturbi di guida
FR Fonction AUDIT pour l'identification des problèmes de conduite
DE Funktion AUDIT für die Diagnose der Fahrstörungen
ES Función AUDIT para la identificación de problemas de conducción

VERSIONS

DWA1100^{TRUCK} (with cabinet)

-  **Ergonomic design**
Industrial computer
No moving parts more likely to break
Data update through USB
-  Design ergonomico
 Computer industriale
 Senza parti in movimento più soggette a rotture
 Aggiornamento dati via USB
-  Forme ergonomique
 Ordinateur industriel
 Sans disque en mouvement qui risquent davantage les ruptures
 Mise à jour des données via USB
-  Ergonomisches Design
 Industrieller Computer
 Ohne bewegliche Scheiben, dem stärkeren Bruch ausgesetzt sind
 Daten-Update via USB
-  Diseño ergonómico
 Ordenador industrial
 Sin partes en movimiento con más probabilidad de romperse
 Actualización datos por medio de USB



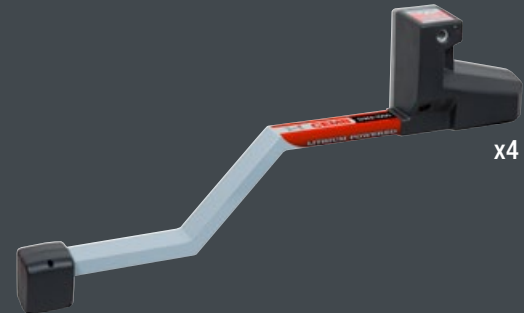

DWA1100^{TRUCK} Light



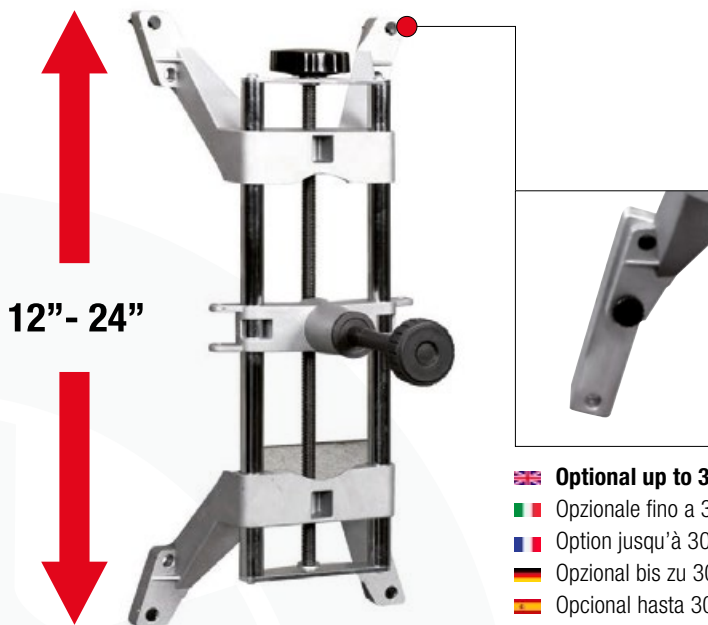

-  **No CABINET!** Save your working space with your laptop!
-  **Senza ARMADIO!** Risparmi spazio di lavoro ed usi il tuo pc!
-  **Sans ARMOIRE!** Gains d'espace de travail et utilisation de son propre PC!
-  **Ohne STEUERSCHRANK!** Sie sparen Raum und benutzen Ihren eigenen PC!
-  **¡Sin ARMARIO!** ¡Ahorras espacio de trabajo y utilizas tu PC!



STANDARD CONFIGURATION





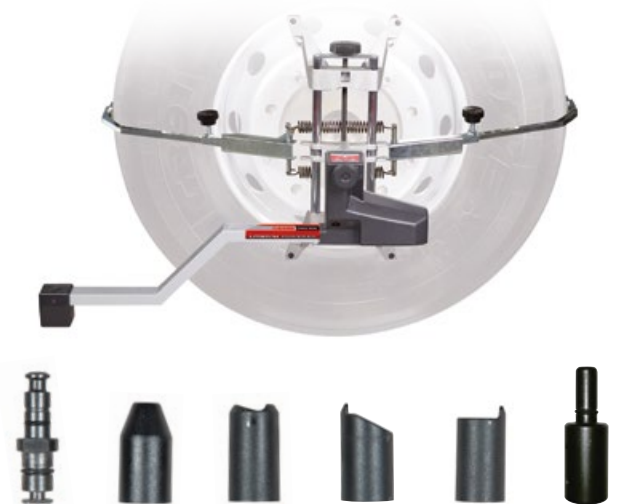

-  **Optional up to 30"**
-  **Opzionale fino a 30"**
-  **Option jusqu'à 30"**
-  **Opzional bis zu 30"**
-  **Opcional hasta 30"**

-  **Metal 120 mm universal grips**, with reference surface, for truck and bus wheels
-  **Unghiette universali 120 mm**, con piano di riferimento, per ruote di autocarro e bus
-  **Onglets universels 120 mm en métal**, avec surface de référence, pour roues de camion et de bus
-  **Universal-Radklammerfingern aus Metall 120 mm**, mit Auflageoberfläche, für Räder von LKWs und Bussen
-  **Uñas universales 120 mm en metal**, con superficie de referimiento, para ruedas de camión y bus





OPTIONAL ACCESSORIES







-  **Clamp supporting arms and set of tips for tyres with external diameter up to 50"**
-  **Bracci e gruppo di puntali per aggrappo in appoggio a pneumatici con diametro esterno fino a 50"**
-  **Bras et groupe de broches pour griffe en appui sur des pneus ayant un diamètre externe jusqu'à 50"**
-  **Klemmarme und Positionsfinger für Radklammern zum Auflegen auf Reifen mit Aussendurchmesser bis zu 50"**
-  **Brazos y grupo de puntales para mordaza en apoyo a neumáticos con diámetro externo hasta 50"**

Grips for all rims and tyres are available



-  **Metal grips for clamping on steel rims from the inside**
-  **Unghiette in metallo per aggrappo dall'interno su cerchi in ferro**
-  **Onglets en métal pour accrochage de l'intérieur sur jantes en fer**
-  **Metallkrallen zum Halten von innen bei Eisenfelgen**
-  **Uñas en metal para mordaza desde el interior en llantas en hierro**

STANDARD COMPOSITION

-  Computer - 27" monitor - printer (only for DWA1100^{TRUCK})
Truck and bus software and database
4 truck sensors
4 clamps + safety elastic band + 1 set of grips
2 Truck turnplates
Steering lock + Brake pedal lock
-  Computer - monitor 27"- stampante (solo per DWA1100^{TRUCK})
Software e database per autocarro e bus
4 rilevatori autocarro
4 aggrappi + elastico di sicurezza + 1 set di unghiette
2 piatti rotanti autocarro
Bloccasterzo + premipedale
-  Ordinateur - moniteur 27"- imprimante (seulement pour DWA1100^{TRUCK})
Logiciel et base de données pour camions et autobus
4 détecteurs camion
4 griffes + élastique de sécurité + 1 jeux d'onglets
2 plateaux rotatifs pour camion
Blocage direction + presseur pédale
-  Industrieller PC, TFT-Bildschirm 27", Drucker (nur für DWA1100^{TRUCK})
Software und Datenbank für LKW und Bussen
4 Messköpfe für LKW
4 Radklammern + elastisches Schutzband + 1 Radklammerfinger
2 vordere Drehteller für LKW
1 Lenkradfeststeller, 1 Bremspedalfeststeller
-  Ordenador - pantalla 27" - impresora (solo para DWA1100^{TRUCK})
Software y base de datos para camión y bus
4 captadores camión
4 mordazas + elástico de seguridad + 1 equipos de uñas
2 platos rotatorios camión
Dispositivo antirrobo + apretapedal

TECHNICAL DATA

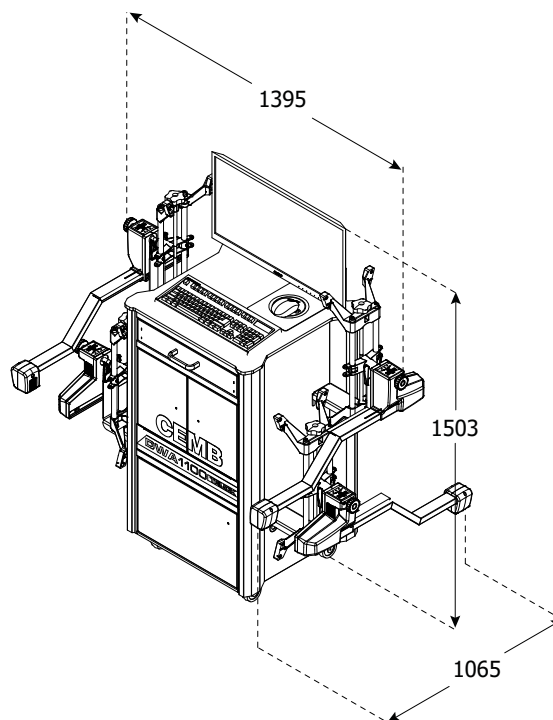





PACKAGE DIMENSIONS AND GROSS WEIGHT:

TYPE: 113x113x113 cm (44,5x44,5x44,5") 220 Kg





Net weight: 155 Kg

OPTIONS



-  Adaptor rod for semitrailers' king pin
-  Barra semirimorchio per perno ralla
-  Barre semi-remorque pour axe couronne
-  Sattelzug bar für Achsschenkelbolzen
-  Palanca semiremolque para perno rangua







-  Car and light truck upgrade Kit
-  Kit di conversione auto
-  Kit de conversion voiture
-  Pkw Nachrüstatz
-  Equipo de conversión coche



-  Ramps for truck turnplates
-  Rampe per piatti girevoli autocarro
-  Rampes pour plateaux P.L.
-  Rampen für LKW-Drehteller
-  Rampas para platos rotatorios camión



-  WiFi connection for automatic software updates
-  Collegamento wifi per l'aggiornamento automatico del software
-  Connexion Wi-Fi pour la mise à jour du logiciel
-  Wifi-Verbindung zur automatischen Aktualisierung der Software
-  Conexión wifi para actualizar automáticamente el software



CEMB

BALANCING MACHINES

CEMB S.p.A.

Via Risorgimento, 9
23826 Mandello del Lario (LC) - Italy

www.cemb.com



Garage equipment division
CEMB - ITALY
Plant and Training Center
Phone +39 0341 706111
garage@cemb.com

CEMB USA - BL Systems Inc.
2873 Ramsey Road
Gainesville, GA 30501 - USA
Phone +001 678 717 1050
Fax +001 678 717 1056
sales@cemb-usa.com



All the data and features mentioned in this catalogue are purely for information and do not constitute any commitment on the part of our company, which reserves the right to make any and all alterations it may consider suitable without notice.