





DWA 3500



3D HD WHEEL ALIGNMENT FOR CAR AND LIGHT TRUCK

-  3D-HD wheel aligner with movable camera automatically adjustable with lift height
-  Assetto ruote 3D-HD con camere autoregolabili in base all'altezza del ponte
-  Appareil de géométrie en trois dimensions HD avec élévateur caméra automatiquement réglable en hauteur avec l'élévateur
-  3D-HD-Achsmessgerät mit je nach Höhe der Hebebühne selbstregulierenden Kameras
-  Equipo de alineación de ruedas en 3D-HD barra de cámaras regulable automáticamente con elevador de altura



CEMB



DWA 3500

🇬🇧 **Movable cameras** automatically adjustable with lift height
Quarterly updates of the data bank for clear, rapid selection of different versions of vehicles
Frontal assistance video camera to help get onto the lift

🇮🇹 **Telecamere mobili** regolabili automaticamente in base all'altezza del ponte
Aggiornamenti quadrimestrali della banca dati per una selezione rapida e chiara delle diverse versioni dei veicoli
Videocamera frontale di aiuto alla salita sul ponte

🇫🇷 **Élévateur caméra** automatiquement réglable en hauteur avec l'élévateur
Mises à jour quadrimestrielles de la base de données afin de permettre la sélection rapide et claire des différentes versions de véhicule
Caméra vidéo frontale d'aide à la montée sur le pont

🇩🇪 **Mobile Kameras**, die je nach Höhe der Hebebühne automatisch regulierbar sind
Viermonatliche Aktualisierungen der Datenbank für eine schnelle und übersichtliche Auswahl der verschiedenen Fahrzeugversionen
Vordere Hilfs-Videokamera an der Auffahrt der Hebebühne

🇪🇸 **Cámaras móviles** automáticamente regulables con la altura del puente elevador
Actualización cuatrimestral de la base de datos para una selección rápida y clara de las distintas versiones de los vehículos
Videocámara delantera de ayuda para subir al puente

ADVANCED SOFTWARE

🇬🇧 **Wheelbase, track and diagonal measurements** to prevent damage from accidents
Wheel diameter measurements to verify correct pressure
Single raised wheel run-out for smaller workspaces or lifts with stairs
Measurements with 2 targets for long vehicles
Caster angle and friction range measurements
Audit Function: identification of driving problems, resulting from measures not contemplated in the specifications to support the regulation service

🇮🇹 **Misura di passo, carreggiata e diagonali** per il controllo di eventuali danni da incidenti
Misura del diametro delle ruote per verificarne la corretta pressione
Run-out a ruota singola sollevata nel caso di spazi di lavoro ridotti o di ponti con scalini
Misura con 2 bersagli per i veicoli lunghi
Misurazione di braccio a terra e raggio d'attrito
Funzione Audit: diagnosi dei disturbi di guida, conseguenti a misure fuori specifica, per supportare la vendita del servizio di regolazione

🇫🇷 **Mesure de pas, largeur et diagonales** pour le contrôle des éventuels dommages dus à des accidents
Mesure du diamètre des roues pour en vérifier la pression correcte
Mesure de l'excentricité à roue indépendante soulevée si l'espace de travail est réduit ou si le pont à des marches
Mesure avec 2 cibles pour les véhicules longs
Mesure de bras à terre et rayon de frottement
Fonction Audit: diagnostic des problèmes de conduite à la suite de mesures hors spécification, pour supporter la vente du service de réglage

🇩🇪 **Messung von Radstand, Spurweite und Diagonalen** zur Kontrolle eventueller Unfallschäden

Messung des Raddurchmessers zur Kontrolle des korrekten Drucks
Run-out am einzelnen angehobenen Rad bei Platzmangel oder Stufen-Hebebühnen

Messung mit 2 Zielscheiben für lange Fahrzeuge
Messung von Caster und Reibungsradius

Funktion Audit: Die Diagnose der Fahrstörungen infolge von Messungen außerhalb der Toleranz erleichtert den Verkauf des Service zur Regulierung

🇪🇸 **Medida de paso, superficie de rodadura y diagonales** para el control de posibles daños debidos a accidentes

Medida del diámetro de las ruedas para comprobar que la presión es correcta

Desviación con una rueda levantada en lugares de trabajo con espacio reducido o puentes con escalones

Medida con 2 puntos de referencia en vehículos largos
Medida de brazo en el suelo y radio de rozamiento

Función Audit: diagnóstico de problemas de conducción debidos a medidas que no cumplen las especificaciones como argumento de venta del servicio de reglaje



TARGETS

🇬🇧 **Compact Targets** with no electronics and batteries





🇮🇹 **Bersagli compatti** senza elettronica e batterie

🇫🇷 **Cibles compactes** sans électronique et batteries

🇩🇪 **Kompakte Zielscheiben** ohne Elektronik oder Batterien

🇪🇸 **Reflectores compactos** sin electrónica o baterías

CABINET

-  **Ergonomic design** and easy accessibility during maintenance operations
Industrial computer with Windows 10 and SSD memory, without moving disks more likely to break
WiFi connection for automatic software updates
-  **Design ergonomic** e facile accessibilità in caso di manutenzione
Computer industriale Windows 10 con memoria SSD, senza dischi in movimento più soggetti a rotture
Collegamento wifi per l'aggiornamento automatico del software
-  **Forme ergonomique** et accès facile en cas d'entretien
Ordinateur industriel Windows 10 avec mémoire SSD, sans disque en mouvement qui risquent davantage les ruptures
Connexion Wi-Fi pour la mise à jour du logiciel
-  **Ergonomisches Design** und leichter Zugang für Wartungsarbeiten
Industrieller Computer Windows 10 mit SSD-Speicher, ohne bewegliche Scheiben, dem stärkeren Bruch ausgesetzt sind
Wifi-Verbindung zur automatischen Aktualisierung der Software
-  **Diseño ergonómico** y de fácil acceso en caso de mantenimiento
Ordenador industrial Windows 10 con memoria SSD, sin discos móviles con más probabilidad de romperse
Conexión wifi para actualizar automáticamente el software

AVAILABLE IN TWO VERSIONS:

STANDARD with 43" monitor

PIT with double monitor (27" and 21") to ease the adjustment in pit

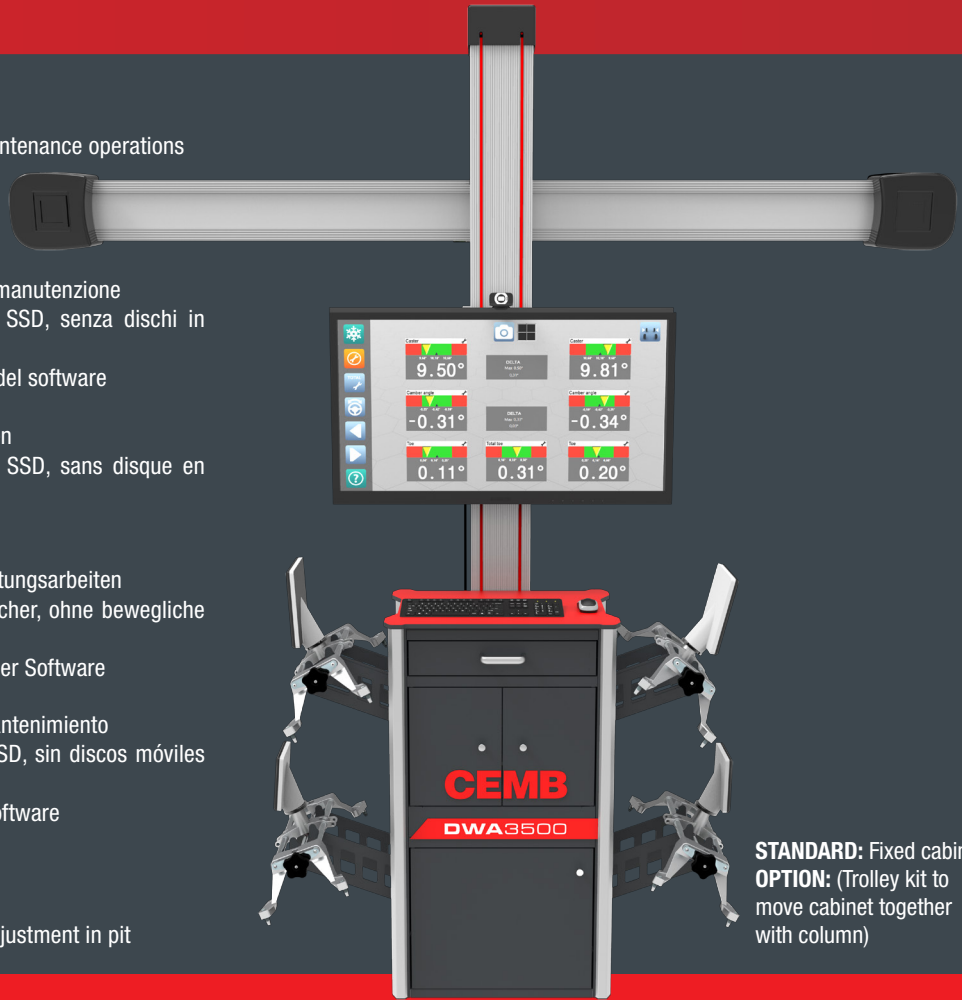



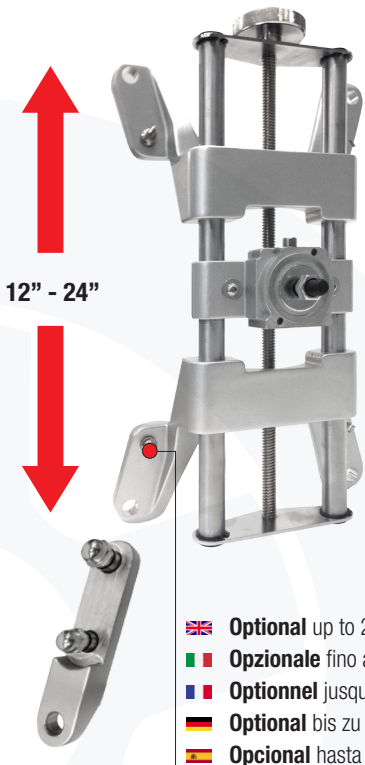

STANDARD: Fixed cabinet
OPTION: (Trolley kit to move cabinet together with column)

STANDARD CONFIGURATION



12" - 24"

-  **Optional** up to 27"
-  **Opzionale** fino a 27"
-  **Optionnel** jusqu'à 27"
-  **Optional** bis zu 27"
-  **Opcional** hasta 27"





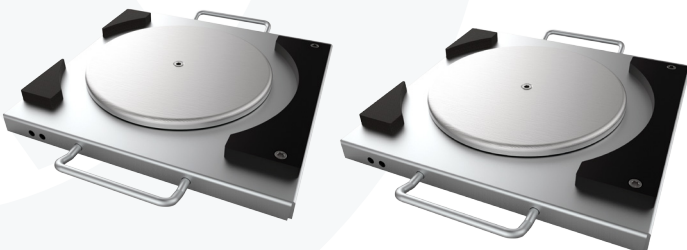

-  **Premium turntables:** capacity 1000 kg per plate, diameter 35 cm, with rubber supports
-  **Piatti Premium:** portata 1000 kg per piatto, diametro 35 cm, con supporti in gomma
-  **Plateaux Premium:** portée 1000 kg par plateau, diamètre 35 cm, avec supports en caoutchouc
-  **Premium-Teller:** Tragkraft 1000 kg pro Teller, Durchmesser 35 cm, mit Auflagen aus Gummi
-  **Platos Premium:** capacidad de 1000 kg por plato, 35 cm de diámetro, con soportes de goma

-  **Universal grips** with locking system
-  **Unghiette universali** con sistema di bloccaggio
-  **Onglets universels** avec système de blocage
-  **Universalradklammerfinger** mit Spannsystem
-  **Uñas universales** con sistema de bloqueo



OPTIONAL ACCESSORIES

-  Automatic locking/unlocking turntables
-  Piatti rotanti con blocco/sblocco automatico
-  Plateaux pivotants avec blocage/déblocage automatiques
-  Drehplatte mit automatischer Blockierung/Lösen
-  Placas giratorias con bloqueo /desbloqueo automático

STANDARD COMPOSITION

🇬🇧 Cabinet

Computer with WINDOWS 10 operating system
43" TFT monitor, colour printer, wifi keyboard, loudspeakers, front webcam, wifi pen drive
Four 4-point clamps 12"-24" with universal grips and targets
Camera support with automatic control
Brake pedal lock, steering lock
Wheel alignment software and database for CARS

🇮🇹 Armadio

Computer con sistema operativo WINDOWS 10
Monitor 43" TFT, stampante a colori, tastiera wifi, altoparlanti, videocamera frontale, chiavetta wifi
Quattro aggrappi a 4 punti 12"-24" con unghiette universali e bersagli
Supporto camere con comando automatico
Premipedale, blocca sterzo
Software e database autoveicoli

🇫🇷 Armoire

Ordinateur avec système d'exploitation WINDOWS 10
Moniteur 43", imprimante couleur, clavier wifi, haut-parleurs, caméra vidéo frontale, clé wifi
Quatre griffes à 4 points 12"-24" avec ongles universels et cibles
Élévateur caméras avec contrôle automatique
Presseur pédale, blocage direction
Logiciel et base de données pour autos

🇩🇪 Steuerschrank

Computer mit Betriebssystem WINDOWS 10
43"-TFT-Monitor, Farbdrucker, Tastatur wifi, Lautsprecher, Vordere Videokamera, Wifi-Stick
4 Radklammern mit 4 Kontaktpunkten (12-24") mit Universalradklammerfingern und Zielscheiben
Kamera-Halterung mit automatischer Steuerung
Pedalbetätigung, Lenkradfeststeller
Software und Database für Fahrzeugen

🇪🇸 Mueble

Ordenador con sistema operativo WINDOWS 10
Monitor 43" TFT, impresora de color, teclado wifi, altavoz, videocámara delantera, memoria wifi
Cuatro garras de 4 puntos de 12-24" con uñas universales y reflectores
Soporte de cámaras con mando automático
Bloqueo de volante, depresor de freno
Software y base de datos para coches

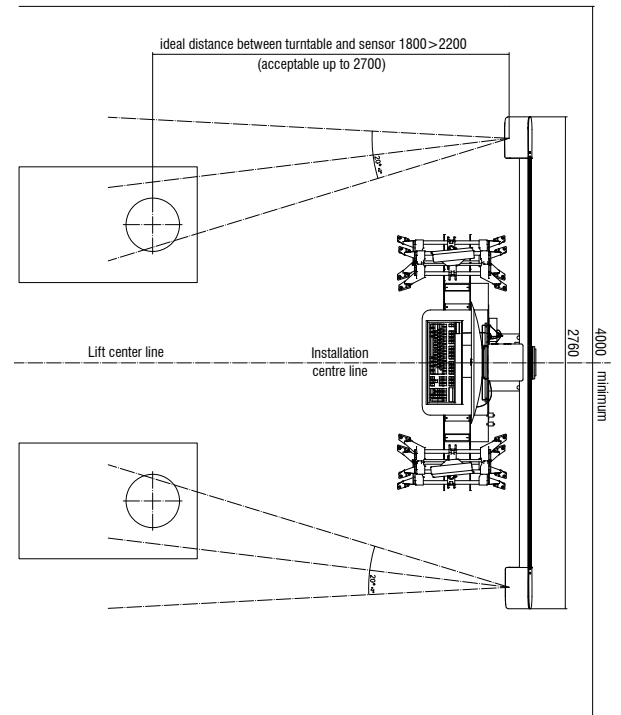
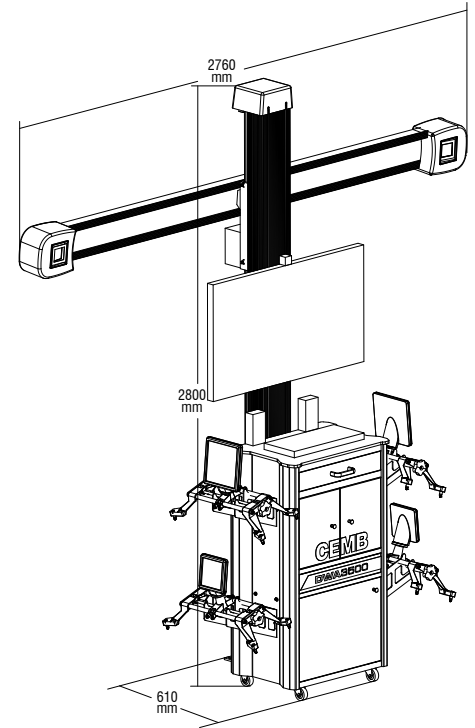

Available only in selected countries
Disponibile solo in paesi selezionati
Disponibile seulement dans pays sélectionnés
Disponibile sólo en los países seleccionados
Nur in ausgewählten Ländern erhältlich



CEMB

BALANCING MACHINES

CEMB S.p.A.

Via Risorgimento, 9
23826 Mandello del Lario (LC) - Italy
www.cemb.com



Garage equipment division
CEMB - ITALY
Plant and Training Center
Phone +39 0341 706111
garage@cemb.com

CEMB USA - BL Systems Inc.
2873 Ramsey Road
Gainesville, GA 30501 - USA
Phone +001 678 717 1050
Fax +001 678 717 1056
sales@cemb-usa.com



All the data and features mentioned in this catalogue are purely for information and do not constitute any commitment on the part of our company, which reserves the right to make any and all alterations it may consider suitable without notice.